

Standard : EMERGENCY LED DRIVERS SPECIFICATION

Model: ELD07UNV/ELD07UNV-C

Input voltage :	AC 120 - 277V, 60 Hz
Input current :	0.02 - 0.05A
Input Power :	2.5 - 4.0 W
Output voltage :	30 - 80 V
Output current :	0.20 (max) A
Output power	8.5(max) W
Battery :	Ni-cad battery, 4.8V/4000mAh
Charging current	0.25 (max) A
Discharge current	2.0 (max) A
Recharging time	24 hours
Discharging time	90 min
Operating ambient Temp. :	0 ~ 50 °C
Dimension :	L : 280 mm, W : 65.2 mm, H : 40 mm
Weight :	1.2 Kg

[DIMENSION]

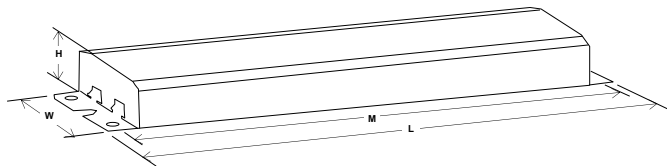

Physical Parameters : inch / cm

L : 11.02/28.0
W : 2.57/6.52
H : 1.57/4.0
M : 10/25.4

[MODEL]

ELD07UNV : Non-conduit model
 ELD07UNV-C : model with conduit

Standard : EMERGENCY LED DRIVERS SPECIFICATION

Model: ELD07UNV/ELD07UNV-C

[WIRING DIAGRAM]

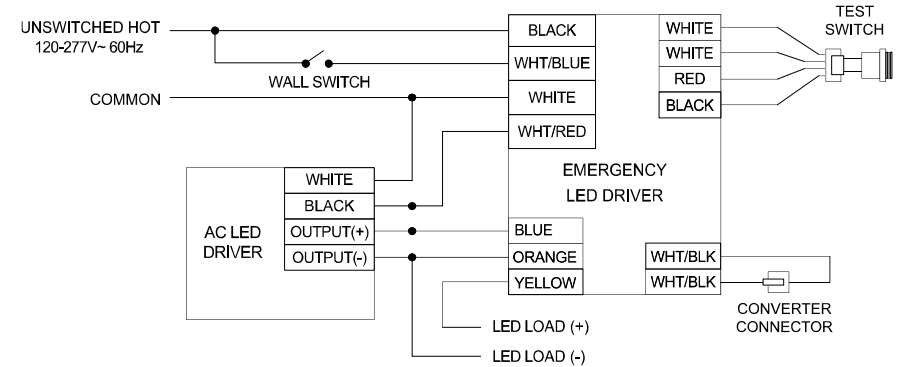

[PICTURE]



ELD07UNV



ELD07UNV-C